

Article number: 0102070

Description: Retaining ring J53 DIN472  
Spring steel

## Measures

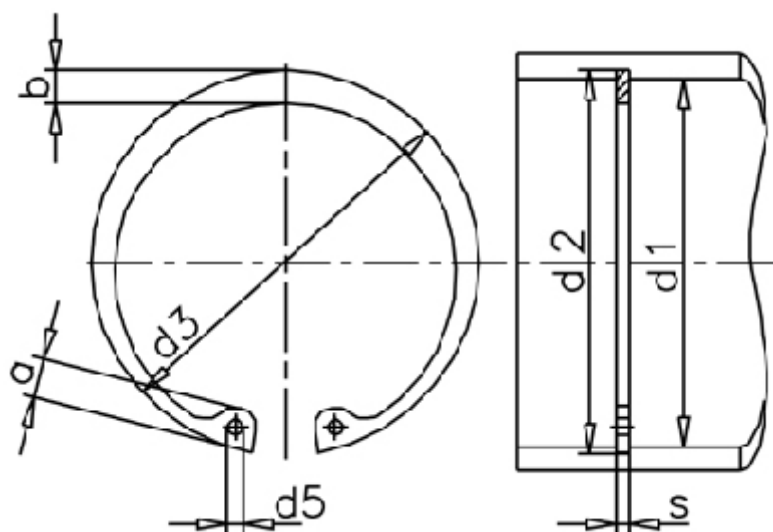

a max	= 6.7	FN kN	= 42.90	t	= 1.50
AN mm <sup>2</sup>	= 257.0	FRg kN	= 12.1	tol	= +0,30
b	= 4.9	FR kN	= 60.7	tol	= +1,10-0,46
d1	= 53	g	= 2.0	tol	= -0.07
d2	= 56.0	K kN-mm	= 110.0	Tong	= ZGJ-3
d3	= 57.20	m min	= 2.15	Weight kg/1000	= 8.22
d5 min	= 2.5	Nominal drive	= 4.5		
Description = J 53		s	= 2.00		